

# SEWING WITH KIDS

Sample Book

[www.yellowspool.com](http://www.yellowspool.com)

# PARTS OF THE SEWING MACHINE

(ANSWER KEY)

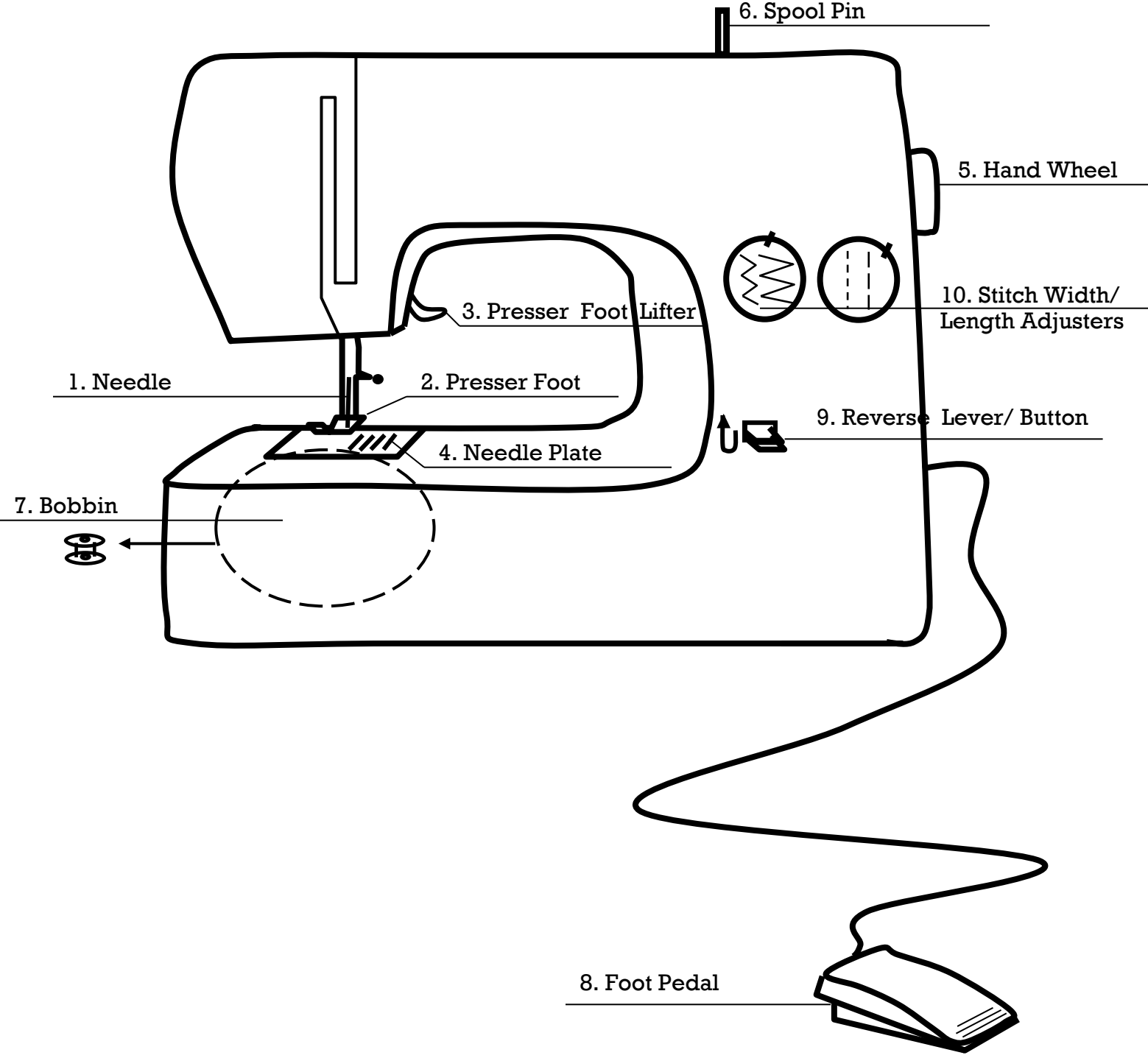

# PARTS OF THE SEWING MACHINE

---

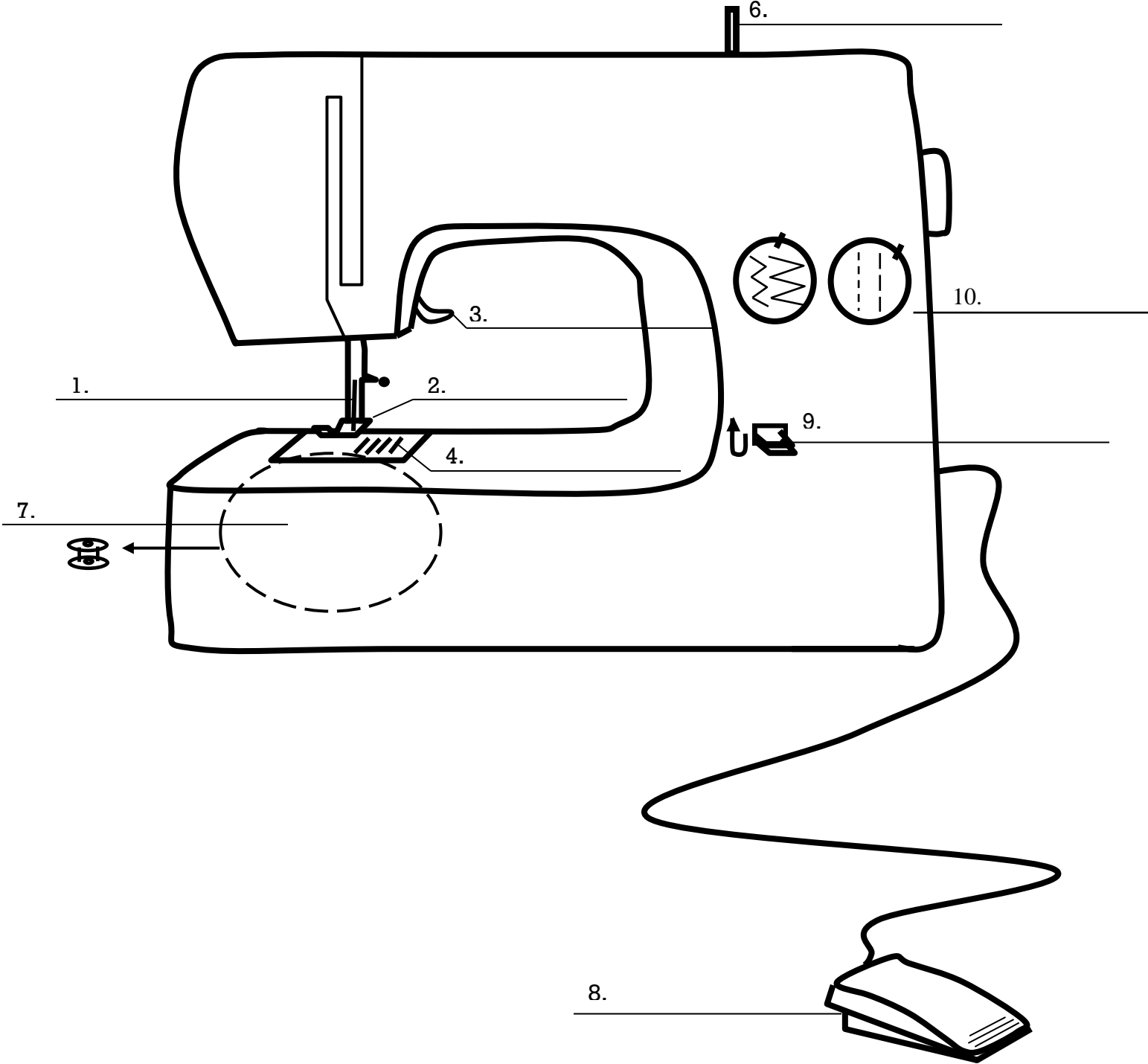

# PARTS OF THE SEWING MACHINE

(WITH WORD BANK)

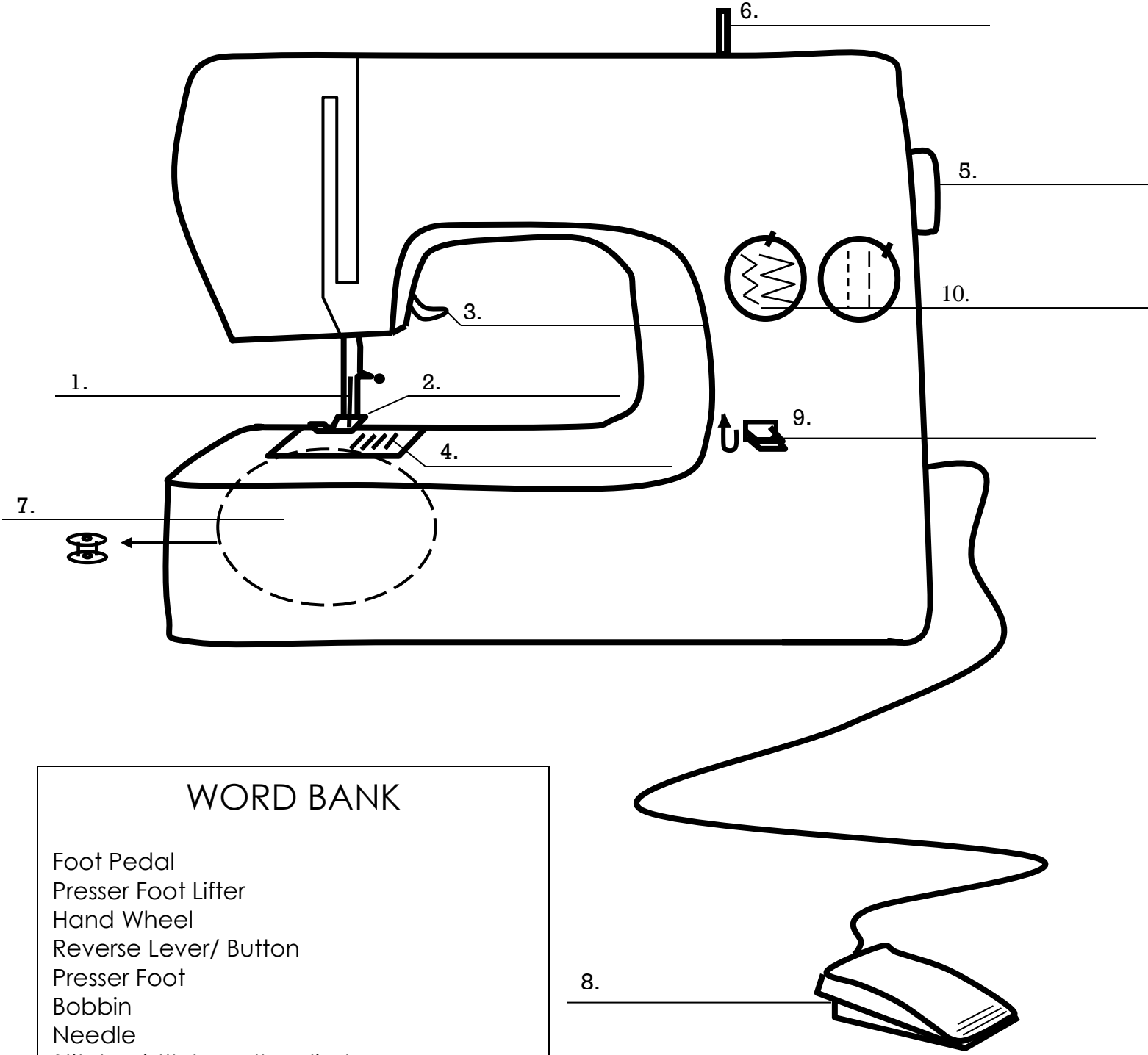

**WORD BANK**

- Foot Pedal
- Presser Foot Lifter
- Hand Wheel
- Reverse Lever/ Button
- Presser Foot
- Bobbin
- Needle
- Stitch Width/Length Adjusters
- Spool Pin
- Needle Plate

8.

1 2 3 4 5 6 7 8 9 10

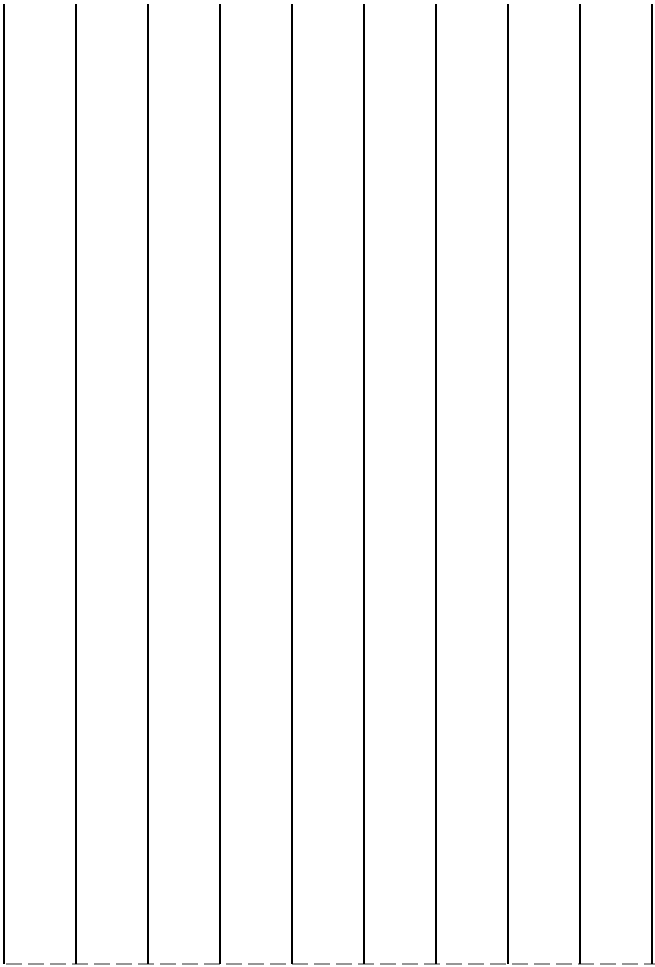

STRAIGHT LINES

REINFORCED STITCHES

CORNERS

# SEWING A STRAIGHT LINE

---

## STRAIGHT LINE

When trace stitching a straight line, you guide at the needle. This means there will be a marking on the fabric showing exactly where to stitch.

Most often, we sew using a seam allowance, instead. The seam allowance is the space between the stitching and the edge of the fabric. Use the markings on the needle plate to guide and determine the seam allowance.

## REINFORCED STITCH

Stitches can be pulled out, unless sewn with reinforcing stitches at the beginning and end to hold them in place. Push the reverse button as you sew to sew backwards over the first few stitches and hold the seam together. It's similar to tying a knot, only on the sewing machine.

## CORNER

Sewing around a corner requires stopping with the needle down before you reach the edge. Lift the presser foot, turn the fabric, put the presser foot back down, and keep sewing.

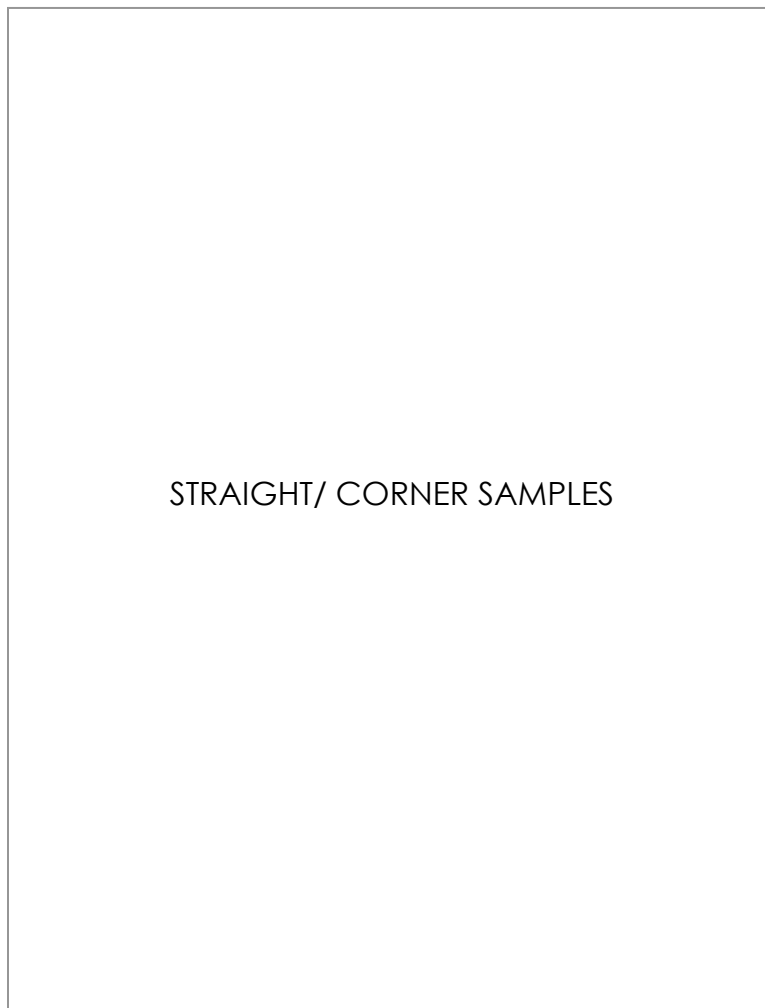

# HAND STITCHING

---

## SEWING ON A BUTTON

Pull the needle up through one of your button's holes. Thread it back down through the hole directly across from the point you came up through. Repeat a few times, until you feel the button is secure. To create a shank, bring the needle between the button and the fabric and wrap it around the button several times.

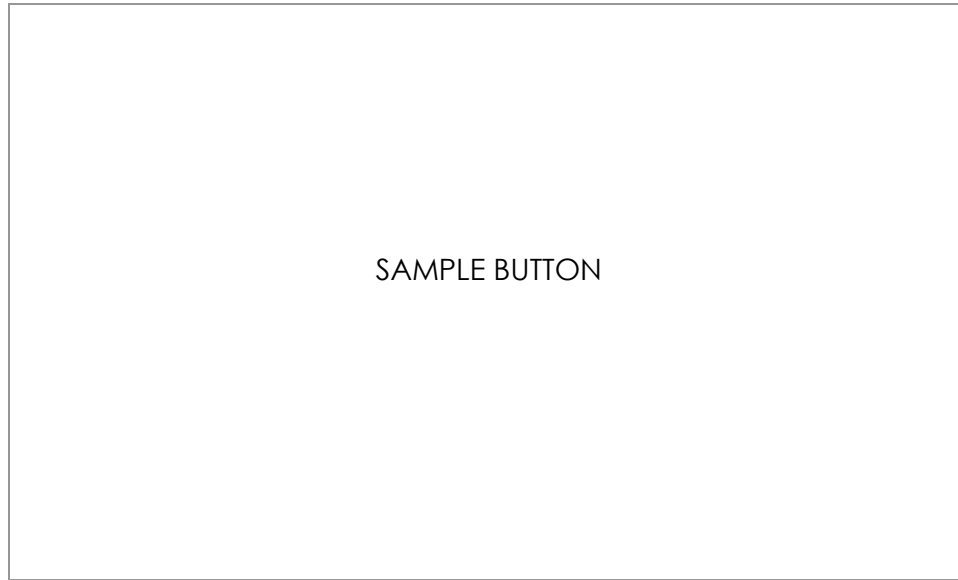

## WHIP STITCH

Pull the needle through from the back. Bring the needle all the way around the edge and up then through both layers, about 1/8" from the starting point. Repeat.



# HAND STITCHING

---

## RUNNING STITCH

Bring the needle up through both layers from the wrong side of the fabric. Create small stitches, moving in a down-over, up-over motion in one direction.



## BACK STITCH

Bring the thread up at the starting point from the back side of the fabric. Push the needle down into the fabric creating one small stitch. Bring the needle back up next to the first stitch. Move the needle back one step, inserting into the same place you finished the first stitch. That is called the "back stitch" and it closes that second stitch. Bring the needle back up in the same place you did in for the previous stitch and repeat.





# SWIRVY CURVY TEMPLATE

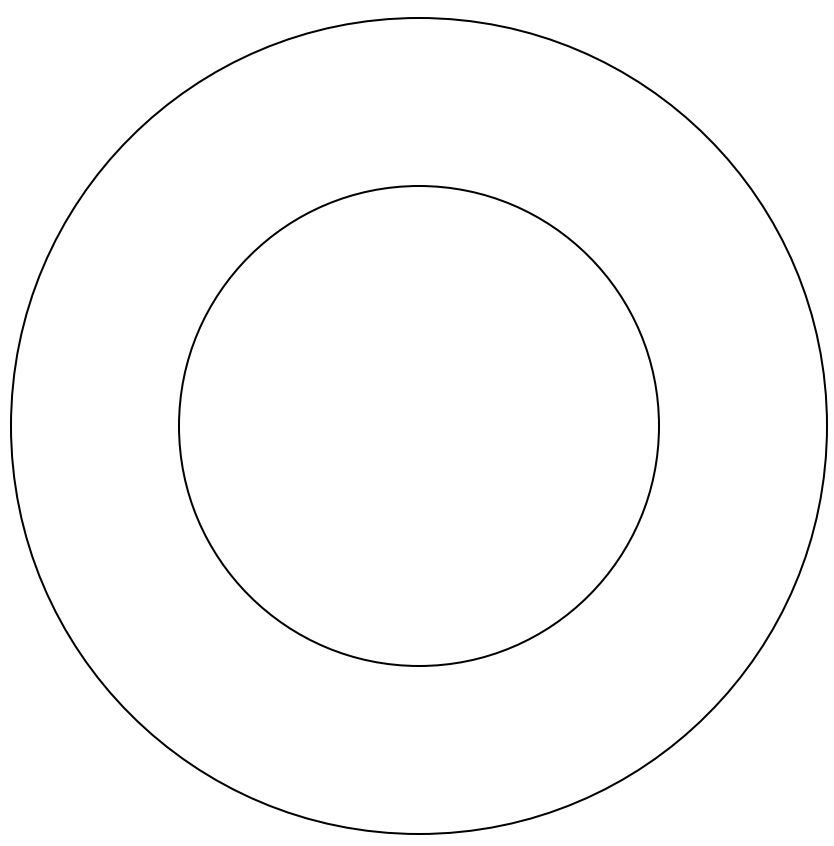
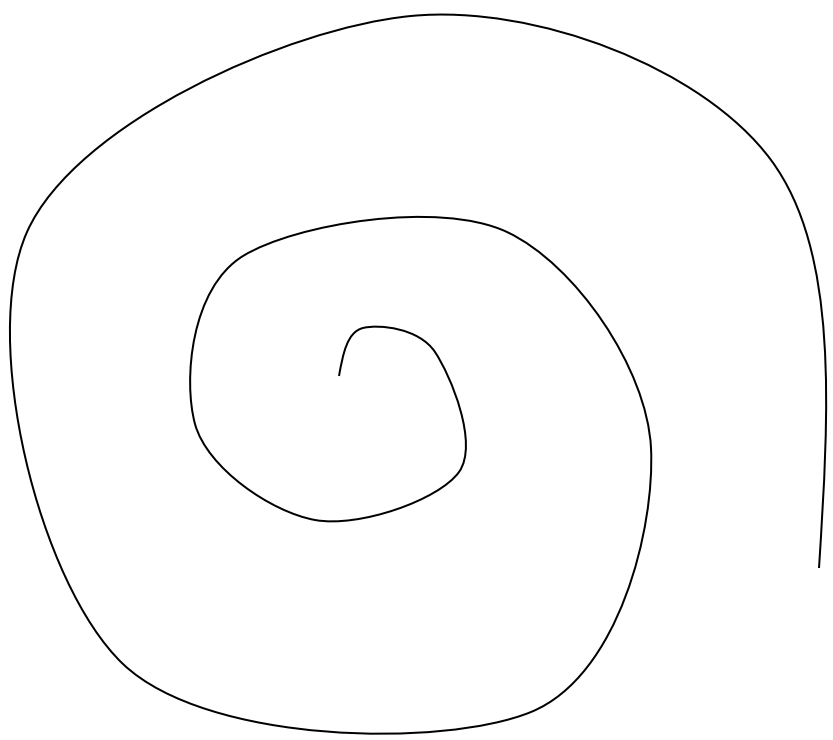
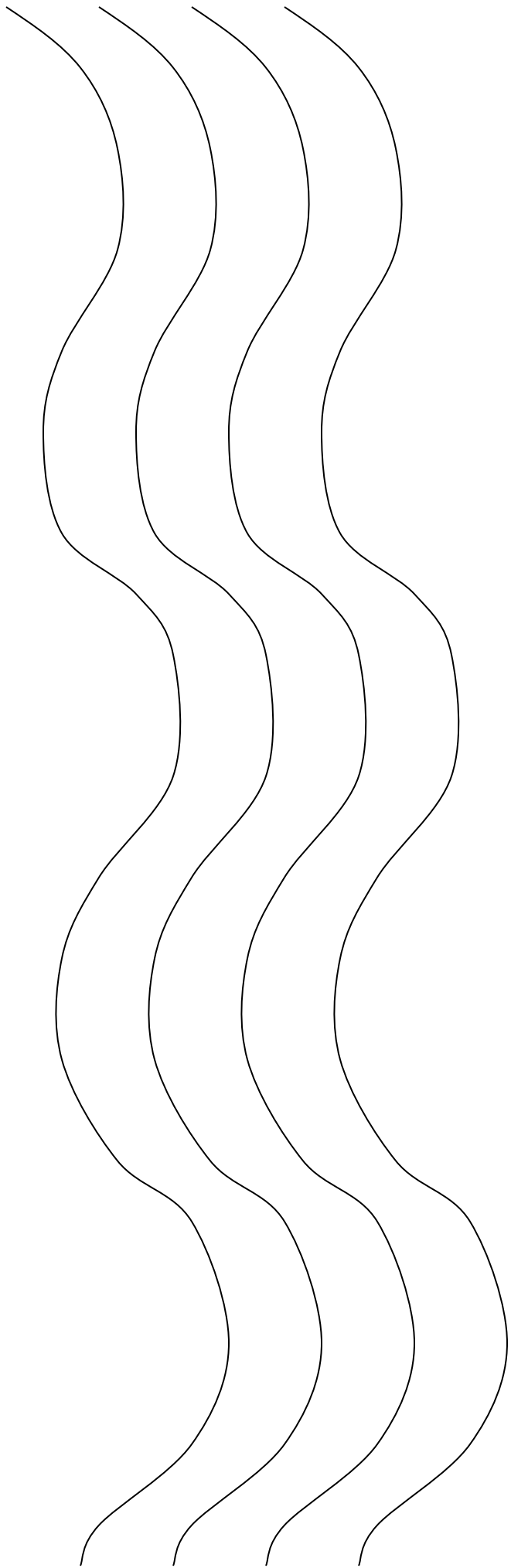

# SEWING ON A CURVE

---

## TRACE STITCHING ON A CURVE

When trace stitching a curved line, you guide at the needle. This means there will be a marking on the fabric showing exactly where to stitch. (Swirvy Curvy Template)

## SEWING A CURVED SEAM ALLOWANCE

The trick to sewing a curve is to see the big picture. Don't focus too much on where the edge of the fabric is before or after the point of the needle.



CURVE SAMPLES

# RIBBON CASING

---

Sew down the side seam and press the seam open. Press the top edge (where the casing will be) under 1" to the wrong side of the fabric. Press the edges of the ribbon under. Pin the ribbon evenly to the right side of the fabric, near the fold. Top stitch at the top and bottom. Thread the drawstring through.



CASING SAMPLE

# ADJUSTING STITCH LENGTH

---

STANDARD LENGTH

+ LENGTH

- LENGTH



# ADJUSTING STITCH WIDTH

---

STANDARD WIDTH

+ WIDTH

- WIDTH

